



Reference Monitor Meters User Handbook

- RM-M1F53** 1 Stereo 53 Segment Meter, Free-Standing
- RM-M1R53** 1 Stereo 53 Segment Meter, Rack-Mount
- RM-M2F53** 2 Stereo 53 Segment Meters, Free-Standing
- RM-M2R53** 2 Stereo 53 Segment Meters, Rack-Mount
- RM-M4R53** 4 Stereo 53 Segment Meters, Rack-Mount
- RM-M1F106** 1 Stereo 106 Segment Meter, Free-Standing
- RM-M1R106** 1 Stereo 106 Segment Meter, Rack-Mount
- RM-M2R106** 2 Stereo 106 Segment Meters, Rack-Mount



REFERENCE MONITOR METERS USER HANDBOOK

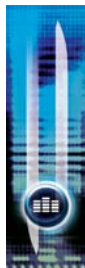

REFERENCE MONITOR METERS USER HANDBOOK

This handbook is for use with the following product:

RM-M1F53 1 Stereo 53 Segment Meter, Free-Standing
RM-M1R53 1 Stereo 53 Segment Meter, Rack-Mount
RM-M2F53 2 Stereo 53 Segment Meters, Free-Standing
RM-M2R53 2 Stereo 53 Segment Meters, Rack-Mount
RM-M4R53 4 Stereo 53 Segment Meters, Rack-Mount
RM-M1F106 1 Stereo 106 Segment Meter, Free-Standing
RM-M1R106 1 Stereo 106 Segment Meter, Rack-Mount
RM-M2R106 2 Stereo 106 Segment Meters, Rack-Mount

©Sonifex Ltd, 2009-2012
All Rights Reserved
Revision 1.03, June 2012

Sonifex Ltd, 61, Station Road, Irthlingborough,
Northants, NN9 5QE, England.
Tel: +44 (0)1933 650 700
Fax: +44 (0)1933 650 726
Email: sales@sonifex.co.uk
Website: <http://www.sonifex.co.uk>

Information in this document is subject to change without notice and does not represent a commitment on the part of the vendor. Sonifex Ltd shall not be liable for any loss or damage whatsoever arising from the use of information or any error contained in this manual.

No part of this manual may be reproduced or transmitted in any form or by any means, electronic or mechanical, including photocopying, recording, information storage and retrieval systems, for any purpose other than the purchaser's personal use, without the express written permission of Sonifex Ltd. Unless otherwise noted, all names of companies, products and persons contained herein are part of a completely fictitious adaptation and are designed solely to document the use of Sonifex product.

Made in the UK by **SONIFEX**



Warranty	i
Warranty and Liability	i
Unpacking the Reference Monitor Meter	iii
Returning the Warranty Card	iii
Safety Information	iv
Safety of Mains Operated Equipment	iv
Voltage Setting Checks	iv
Fuse Rating	iv
Power Cable and Connection	iv
Ordering the Correct Mains Lead	v
Installation Information	v
Atmosphere	v
Electromagnetic Radiation	v
WEEE & RoHS Directives - Sonifex Statement	vi
Reference Monitor Meters Introduction	1
System Block Diagram	2
Front Panel Indicators & Controls	3
Power LED	3
AES Lock LED	3
Level Alarm LED	4
Input Select Button (RM-M1-106 Only)	4
Main Meters	4
Table 1 – Meter Characteristic DIPSwitch settings	6
Meter Labelling	6
Brightness Control	7
Phase Meter	7
Reset Button	7
Rear Panel Connections & Operation	8
Mains Power	8
Audio Inputs	8
Digital Input Termination	8
Input Gain Adjustment	9
Table 2 – Input Gain DIPSwitch Settings	9
Remote Inputs and Outputs	10
Table 3 – Remote Input and Output Connection Details	11
RS232 Remote Control	11
Force Bootloader Mode	11
Serial Interface Commands & Responses Protocol	12
Serial Data Format	12
Error Messages	15
Reference Monitor Meters SCi Remote Control Software	16

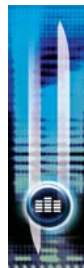

CONTENTS

FIGURES

Contents (Continued)...

Connecting the RS232 Serial Port	16
Using SCI for the First Time	16
Loaded Launcher	17
SCI for Reference Monitor Meters – Main Screen	17
SCI for Reference Monitor Meters – Options Screen	18
Firmware Updates	20
The Misc screen shows the Update Firmware option.	20

Technical Specification

21

Figures

Fig A: Packing List	iii
Fig B: Power Connections	iv
Fig C: Mains Lead Table	v
Fig 1-1: Reference Monitor Meters Block Diagram	2
Fig 1-2: RM-M1-53 Front Panel	3
Fig 1-3: RM-M2-53 Front Panel	3
Fig 1-4: RM-M1-106 Front Panel	3
Fig 1-5: Meter Labelling Options – 53 Segment Display	6
Fig 1-6: Meter Labelling Options – 106 Segment Display	6
Fig 1-7: Brightness Control	7
Fig 1-8: Phase Meter	7
Fig 1-9: Reset Button	7
Fig 1-10: RM-M2-53 Rear Panel	8
Fig 3-1: SCI Launcher	16
Fig 3-2: SCI Device Discovery Panel	16
Fig 3-3: SCI Launcher Loaded	17
Fig 3-4: SCI Main Status Screen for RM-M2-53	17
Fig 3-5: SCI Main Status Screen for RM-M1-106	18
Fig 3-6: SCI Options Screen	18
Fig 3-7: SCI Misc Screen	20



Warranty

Warranty and Liability

Important: the purchaser is advised to read this clause

- (a) The Company agrees to repair or (at its discretion) replace Goods which are found to be defective (fair wear and tear excepted) and which are returned to the Company within 12 months of the date of despatch provided that each of the following are satisfied:
- (i) notification of any defect is given to the Company immediately upon its becoming apparent to the Purchaser;
 - (ii) the Goods have only been operated under normal operating conditions and have only been subject to normal use (and in particular the Goods must have been correctly connected and must not have been subject to high voltage or to ionising radiation and must not have been used contrary to the Company's technical recommendations);
 - (iii) the Goods are returned to the Company's premises at the Purchaser's expense;
 - (iv) any Goods or parts of Goods replaced shall become the property of the Company;
 - (v) no work whatsoever (other than normal and proper maintenance) has been carried out to the Goods or any part of the Goods without the Company's prior written consent;
 - (vi) the defect has not arisen from a design made, furnished or specified by the Purchaser;
 - (vii) the Goods have been assembled or incorporated into other goods only in accordance with any instructions issued by the Company;
 - (viii) the defect has not arisen from a design modified by the Purchaser;
 - (ix) the defect has not arisen from an item manufactured by a person other than the Company.

In respect of any item manufactured by a person other than the Company, the Purchaser shall only be entitled to the benefit of any warranty or guarantee provided by such manufacturer to the Company.

- (b) In respect of computer software supplied by the Company the Company does not warrant that the use of the software will be uninterrupted or error free.
- (c) The Company accepts liability:
- (i) for death or personal injury to the extent that it results from the negligence of the Company, its employees (whilst in the course of their employment) or its agents (in the course of the agency);
 - (ii) for any breach by the Company of any statutory undertaking as to title, quiet possession and freedom from encumbrance.

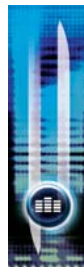

WARRANTY

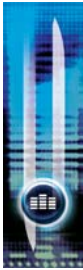

WARRANTY

- 
- WARRANTY**
- (d) Subject to conditions (a) and (c) from the time of despatch of the Goods from the Company's premises the Purchaser shall be responsible for any defect in the Goods or loss, damage, nuisance or interference whatsoever consequential economic or otherwise or wastage of material resulting from or caused by or to the Goods. In particular the Company shall not be liable for any loss of profits or other economic losses. The Company accordingly excludes all liability for the same.
 - (e) At the request and expense of the Purchaser the Company will test the Goods to ascertain performance levels and provide a report of the results of that test. The report will be accurate at the time of the test, to the best of the belief and knowledge of the Company, and the Company accepts no liability in respect of its accuracy beyond that set out in Condition (a).
 - (f) Subject to Condition (e) no representation, condition, warranty or other term, express or implied (by statute or otherwise) is given by the Company that the Goods are of any particular quality or standard or will enable the Purchaser to attain any particular performance or result, or will be suitable for any particular purpose or use under specific conditions or will provide any particular capacity, notwithstanding that the requirement for such performance, result or capacity or that such particular purpose or conditions may have been known (or ought to have been known) to the Company, its employees or agents.
 - (g)
 - (i) To the extent that the Company is held legally liable to the Purchaser for any single breach of contract, tort, representation or other act or default, the Company's liability for the same shall not exceed the Price of the Goods.
 - (ii) The restriction of liability in Condition (g)(i) shall not apply to any liability accepted by the Seller in Condition (c).
 - (h) Where the Goods are sold under a consumer transaction (as defined by the Consumer Transactions (Restrictions on Statements) Order 1976) the statutory rights of the Purchaser are not affected by these Conditions of Sale.



Unpacking the Reference Monitor Meter

The Reference Monitor Meter is shipped with the following equipment. Please check your packaging to ensure that you have all of the items below. If anything is missing, please contact the supplier of your equipment immediately.

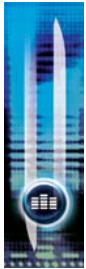

WARRANTY

Product Type	Quantity		
	IEC leads	Handbook, CD & warranty card	Meter scale overlay sheet
RM-M1F53	1	1	1
RM-M1R53	1	1	1
RM-M2F53	1	1	2
RM-M2R53	1	1	2
RM-M4R53	2	1	4
RM-M1F106	1	1	1
RM-M1R106	1	1	1
RM-M2R106	2	1	2

Fig A: Packing List

Each Reference Monitor Meter is shipped in protective packaging and should be inspected for damage before use. Where an item is found to have transit damage, notify the carrier immediately with all the relevant details of the shipment. Packing materials should be kept for inspection and also for if the product needs to be returned.

Returning the Warranty Card

In order to register the date of purchase so that we can keep you informed of any design improvements or modifications, it is important to complete the warranty registration document that is enclosed and return it to Sonifex Ltd in the UK.

For your own records you should write down the serial number (which can be found on the rear of the Reference Monitor Meter).

Serial Number
---------------	-------

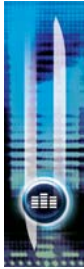

Safety Information

Safety of Mains Operated Equipment



This equipment has been designed to meet the safety regulations currently advised in the country of purchase and it conforms to the safety regulations specified by use of the CE Mark.

Warning : There are no user serviceable parts inside the equipment. If you should ever need to look inside the unit, always disconnect the mains supply before removing the equipment covers.

Voltage Setting Checks

Ensure that the machine operating voltage is correct for your mains power supply by checking the box in which your Reference Monitor Meter was supplied. The voltage is shown on the box label. Please note that all Reference Monitor Meters have a universal power supply, 85-264V AC, 47-63Hz.

Fuse Rating

The Reference Monitor Meter is supplied with a single fuse in the live conducting path of the mains power input. For reasons of safety it is important that the correct rating and type of fuse is used. Incorrectly rated fuses could present a possible fire hazard, under equipment fault conditions. The fuse rating for the Reference Monitor Meter is:

1A 5 x 20mm SB

The active fuse is fitted on the outside rear panel of the unit.

Power Cable and Connection

An IEC power connector is supplied with the Reference Monitor Meter which has a moulded plug attached – this is a legal requirement. If no moulded plug has been supplied with your Reference Monitor Meter, please contact your supplier, because an IEC connector is always supplied from the Sonifex factory.

If for any reason, you need to use the Reference Monitor Meter with a different power cable, you should use the following wiring guidelines.

Wire Colour	Connection
Green, or green and yellow	Earth (E)
Blue, or black	Neutral (N)
Brown, or red	Live (L)

Fig B: Power Connections

Connect the equipment in accordance with the connection details and before applying power to the unit, check that the machine has the correct operating voltage for your mains power supply.

Important Note : The terminal marked on the rear panel must be earthed.

Ordering the Correct Mains Lead

When ordering a Reference Monitor Meter from Sonifex, it is helpful if you can specify your required operating voltage and mains lead. After the product code add:





UK, for 230V, UK 3 pin to IEC lead	
EC, for 230V, European Schuko 2 pin to IEC lead	
US, for 115V, 3 pin to IEC lead	
AU for 230V, Australasian 3 pin to IEC lead	

Fig C: Mains Lead Table

E.g. order RM-M1R53 UK for a UK IEC lead to be supplied.

Installation Information

Atmosphere

The units should be installed in an area that is not subject to excessive temperature variation ($<0^{\circ}\text{C}$, $>50^{\circ}\text{C}$), moisture, dust or vibration.

Electromagnetic Radiation

The cover is connected to earth by means of the fixing screws. It is essential to maintain this earth ground connection to ensure a safe operating environment and provide electromagnetic shielding.

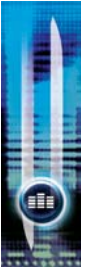

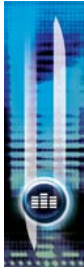

WEEE & RoHS Directives - Sonifex Statement



The Waste Electrical and Electronic Equipment (WEEE) Directive was agreed on 13 February 2003, along with the related Directive 2002/95/EC on Restrictions of the use of certain Hazardous Substances in electrical and electronic equipment (RoHS).

The **Waste Electrical and Electronic Equipment Directive (WEEE)** aims to minimise the impacts of electrical and electronic equipment on the environment during their life times and when they become waste. It applies to a huge spectrum of products. It encourages and sets criteria for the collection, treatment, recycling and recovery of waste electrical and electronic equipment. All products manufactured by Sonifex Ltd have the WEEE directive label placed on the case. It gives a contact for individuals who are unsure about the correct procedure when the product has reached its “end of use”.

Sonifex Ltd will be happy to give you information about local organisations that can reprocess the products, or alternatively all products that have reached “end of use” can be returned to Sonifex and will be reprocessed correctly free of charge.

Sonifex Ltd has phased out the use of certain hazardous substances identified in the European Union’s **Restriction of Hazardous Substances (RoHS)** directive. The RoHS directive limits the use of certain hazardous substances currently used in EEE manufacture, including lead, mercury, cadmium, hexavalent chromium, and halide-containing compounds PBB (polybrominated biphenyl) and PBDE (polybrominated diphenyl ether). Elimination of these substances will result in more environmentally friendly recycling of electronic equipment. For the products which Sonifex manufacture, the main area where products were affected was in the use of lead for manufacturing and assembling electronics circuit boards.

Sonifex Ltd practices lead-free (LF) manufacturing processes. LF solder is used on the surface-mount PCB manufacturing processes and for hand soldering. The printed circuit boards (PCBs) used are either gold plated, or immersion tin plated, both of which use no lead. Historically the PCBs were hot air solder levelled (HASL) PCBs which used tin/lead based solder.

The manufacturing processes include the assembly of purchased components from various sources. Product is offered as RoHS compliant, or LF, only after sufficient evidence is received from the component manufacturers that their components are RoHS compliant. Sonifex Ltd relies solely on the distributor, or manufacturer, of the components for identification of RoHS compliance. Thus whilst every effort is made to ensure compliance, Sonifex Ltd makes no warranty, or certification, or declaration of compliance concerning said components.

Sonifex Ltd defines “Lead Free” as pertaining to any product, which has been manufactured by Sonifex Ltd using components which have been declared by the manufacturers as “Lead Free”. All statements by Sonifex Ltd of RoHS compliance are based on component manufacturer documentation.



REFERENCE MONITOR

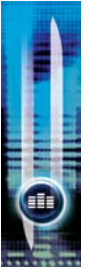

INTRODUCTION

Reference Monitor Meters Introduction

The Reference Monitor Meters offer accurate, high resolution metering of up to 2 stereo audio sources in a compact 1U freestanding or rack mount package. All stereo sources are auto-switching between either analogue or digital AES/EBU formats with sample rates up to 192kHz accepted.

The level of each stereo source is displayed on a pair of bright, multi-coloured bar graph meters, with a choice nine accurately modelled scales/responses to suit different applications and local preferences. Separate phase meters indicate channel correlation or phase error conditions, and additional LEDs show digital input lock and audio level alarm status.

On the rear panel, open-collector alarm outputs provide hardware indication of audio under-level or silence, audio over-level, sustained phase errors above 90 degrees and digital source lock.

Alarm audio threshold levels and time-out durations are all fully configurable via a RS232 connection in conjunction with Sonifex SCi Windows-based remote control software. Status monitoring and unit identification, plus firmware updates to add extra functionality are also supported by the Sonifex SCi software. The open control protocol also allows operation with terminal programs or customised applications.

There are 3 models in the Reference Monitor Meters range which can be supplied in rack-mount, freestanding and twin versions to provide eight different products.

The RM-M1F53 has a single stereo audio input and a pair of 53-segment bar graph meters.

The RM-M2F53 is a dual stereo input version with a pair of 53-segment bar graph meters for each audio input. Separate phase and status LEDs for each audio input are also provided

The RM-M1F106 is a dual stereo audio input version, with a pair of 106-segment bar graph meters for greater display accuracy. A front panel mounted input select switch selects the

audio source to be monitored, from either of the 2 stereo inputs, or from a mono mix of each channel with channel 1 shown on the left meter and channel 2 shown on the right meter.

The Reference Monitor Meters are available in 1U rack mount versions:

- RM-M1R53 Rack mount version of RM-M1F53.
- RM-M2R53 Rack mount version of RM-M2F53.
- RM-M4R53 Dual rack mount version combining 2xRM-M2R53 units providing 4 stereo inputs.
- RM-M1R106 Rack mount version of RM-M1F106.
- RM-M2R106 Dual rack mount version combining 2xRM-M1R106 units providing 4 stereo inputs.

In this document, generic model references are used to refer to features that are relevant to all versions of that particular model, for example:

- RM-M1-53 refers to the RM-M1F53 and the RM-M1R53,
- RM-M2-53 refers to the RM-M2F53 and the RM-M2R53 and
- RM-M1-106 refers to the RM-M1F106 and the RM-M1R106.

All Reference Monitor Meters products operate from global mains voltages (85-264V AC, 47-63Hz) without adjustment.

System Block Diagram

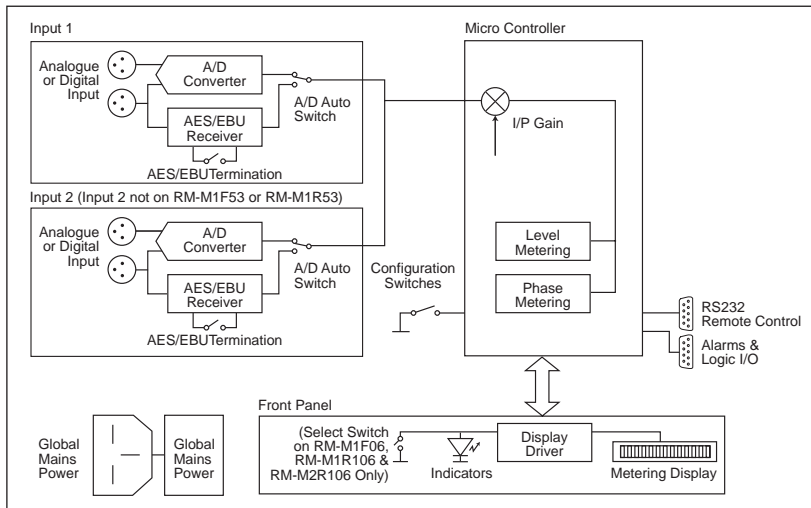

Fig 1-1: Reference Monitor Meters Block Diagram

Front Panel Indicators & Controls



Fig 1-2: RM-M1F53 Front Panel



Fig 1-3: RM-M2F53 Front Panel



Fig 1-4: RM-M1F106 Front Panel

Power LED

The Power LED illuminates whilst internal power is present within the unit. If this indicator is not on, the most likely reason is simply the absence of mains power, but under fault conditions it may also indicate a ruptured mains fuse or a problem with the internal power supply module.

AES Lock LED

The AES Lock LED illuminates when the corresponding audio input is connected to a valid digital AES/EBU audio signal. It will not illuminate if the audio input is an analogue signal, or if a digital audio signal is applied which has a sample rate outside the acceptable range of the unit, contains invalid/non-audio data or is too weak for the receiver to lock on to.

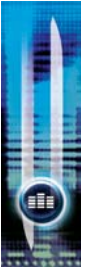

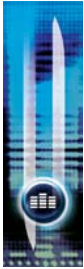

Level Alarm LED

The Level Alarm LED illuminates when the alarm condition setting for the corresponding audio input has been met. By default, the alarm condition is set to Input Clip. With this setting, the Level Alarm LED will illuminate when the input signal level (taking into account any input gain applied) has either exceeded or come within 0.5dB of the maximum acceptable input level. See the section "Reference Monitor Meters Sci Remote Control Software" for further details on additional alarm settings.

Input Select Button (RM-M1-106 Only)

The Input Select Button determines which source is currently routed to the metering. Pressing the button selects the next available source, and the button illumination indicates the current selection. With input 1 selected, the button is not illuminated. When the button illuminates green, the left meter shows a mono mix of input 1 and the right meter shows a mono mix of input 2. When the button illuminates red, input 2 is selected.

When mains power is removed, the currently selected input is stored in non-volatile memory and recalled once power is restored.

Main Meters

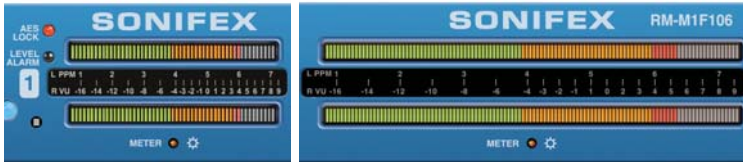
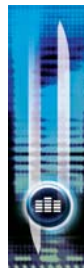

Fig 1-5: RM-M2-53 53 Segment Meter & RM-M1-106 106 Segment Meter

The main meters are made up of 53 or 106 segment, multicoloured LED bar graphs (dependent on model). Units with 53 segment displays will have a pair of bar graphs for each input channel. On all units, the top bar graph is the left channel and the lower bar graph is the right channel.

Several different meter characteristics are available to suit different applications and regional preferences, and each available input channel can be individually set to the required setting. The active meter characteristic is selected using the DIPSwitches in the "Settings 2" bank (found on the rear panel of the unit), according to the following table.



Meter Characteristics	Scale Range*	0dBFS Reference	Amber Section Starts at*	Red Section Starts at*
Dual PPM + Standard VU	-13 to +13dBu	+18dBu	0dBu	+8dBu
BBC PPM or EBU PPM**	-13 to +13dBu	+18dBu	0dBu	+8dBu
Nordic PPM	-40 to +12dBu	+18dBu	0dBu	+6dBu
AES Digital PPM	-52 to 0dBFS	+18dBu	-18dBFS	0dBFS
DIN PPM	-54 to +5dBu	+18dBu	0dBu	+4dBu
Standard VU	-24 to +3VU	+18dBu	-4VU	0VU
Extended VU	-59 to +15VU	+18dBu	-4VU	0VU
German PPM	-54 to +15dBu	#+15dBu	-54dBu	+7dBu
AES Digital PPM (SMPTE RP.0155)	-52 to 0dBFS	+18dBu	-20dBFS	0dBFS

Meter Characteristics	Audio Input 1				Audio Input 2			
	SW1	SW2	SW3	SW4	SW5	SW6	SW7	SW8
Dual PPM + Standard VU	OFF	OFF	OFF	OFF	OFF	OFF	OFF	OFF
BBC PPM or EBU PPM**	ON	OFF	OFF	OFF	ON	OFF	OFF	OFF
Nordic PPM	OFF	ON	OFF	OFF	OFF	ON	OFF	OFF
AES Digital PPM	ON	ON	OFF	OFF	ON	ON	OFF	OFF
DIN PPM	OFF	OFF	ON	OFF	OFF	OFF	ON	OFF
Standard VU	ON	OFF	ON	OFF	ON	OFF	ON	OFF
Extended VU	OFF	ON	ON	OFF	OFF	ON	ON	OFF
German PPM	ON	ON	ON	OFF	ON	ON	ON	OFF
AES Digital PPM (SMPTE RP.0155)	OFF	OFF	OFF	ON	OFF	OFF	OFF	ON

* With 0dB of input gain selected # With 0dB input gain (SW6 and SW7 off)

**May be BBC or EBU PPM depending on the choice of scale plate.

Table 1 – Meter Characteristic DIPSwitch settings

Once the desired meter characteristic has been chosen, proper scale labelling may be ensured by removing the appropriate scale from the backing paper and applying it to the recess provided between the meter bar graphs.

Brightness Control

The brightness of the bar graph meters and all other front panel indicators may be adjusted to suit user preference or to match similar units nearby.

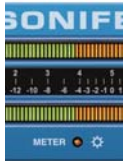

Fig 1-7: Brightness Control

A miniature flat-bladed screwdriver inserted into the hole next to the brightness symbol should be turned clockwise to increase the brightness or anti-clockwise to decrease it.

Phase Meter



Fig 1-8: Phase Meter

The five-segment LED phase meter indicates the average phase correlation between the left and right channels of the corresponding stereo audio input. It is labelled in both degrees of phase shift and amount of correlation. A monophonic signal fed to both channels of the corresponding audio input will have a correlation of 1.0, while inverting one such channel – making it perfectly out of phase – gives a correlation of -1.0. True stereo signals will produce a fluctuating phase correlation.

Reset Button

In the unlikely event that the Reference Monitor Meters unit fails to respond, press the recessed reset button via the small hole in the front panel.



Fig 1-9: Reset Button

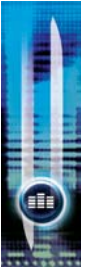



Rear Panel Connections & Operation



Fig 1-10: RM-M2-53 Rear Panel

Mains Power

Power is applied via a standard three-pin IEC male socket. Mains voltages between 85V and 264V AC at frequencies between 47 and 63Hz are accepted without adjustment. A 1A, 5 x 20mm SB fuse is used. The Earth pin **MUST** be connected to ensure safety.

Audio Inputs

Three-pin female XLR connectors are provided for the connection of up to two stereo audio sources (dependent on model). The pin assignments are as follows:

- Pin 1: Ground
- Pin 2: In-phase signal ("hot")
- Pin 3: Out-of-phase signal ("cold")

Unbalanced signals may also be used by linking pins 1 and 3 and applying the unbalanced signal to pin 2. Each of the audio inputs accepts either a pair of analogue line-level signals (using both input XLRs) or a single AES/EBU digital signal (attach to the left-hand XLR of the pair and leave the right-hand XLR unconnected). The unit automatically detects digital audio signals and re-configures the input accordingly. A full-scale digital input signal (0dBFS) corresponds to the maximum analogue input signal level as shown in Table 1 (with no extra input gain applied).

Digital Input Termination

Switchable termination is provided to allow the Reference Monitor Meters inputs to be bridged across an existing AES/EBU connection without double-termination, but this should only be attempted with the terminating equipment mounted adjacent to the Reference Monitor unit and with connections kept as short as possible. It is strongly recommended that the digital input termination is set to ON at all times. Failure to do so may result in unreliable reception of digital input signals and/or crosstalk between sources.

The 110Ω input termination for the AES/EBU digital inputs is controlled by the settings of DIPSwitches 1 and 2 in the "Settings 1" bank (found on the rear panel of the unit) as follows:

- SW1: When set to ON, digital input 1 is terminated with 110Ω.
- SW2: When set to ON, digital input 2 is terminated with 110Ω (valid on 2 channel units only)





Input Gain Adjustment

For both analogue and digital sources the default input gain is zero, i.e. an input of 0dBu results in a reading of 0dBu on the meters. However, to accommodate lower level sources it is possible to introduce extra input gain in 6dB steps. This gain can be applied to each input channel independently, and it is controlled by the settings of DIPswitches 3, 4, 5 and 6 in bank “Settings 1” (found on the rear panel of the unit), according to the following table.

Input Gain	Maximum Signal Level (Analogue Sources)	Maximum Signal Level (Digital Sources)	Audio Input 1		Audio Input 2	
			SW3	SW4	SW5	SW6
0dB	+18dBu (+15dBu for German PPM meter setting)	0dBFS	OFF	OFF	OFF	OFF
+6dB	+12dBu (+9dBu for German PPM meter setting)	-6dBFS	ON	OFF	ON	OFF
+12dB	+6dBu (+3dBu for German PPM meter setting)	-12dBFS	OFF	ON	OFF	ON
+18dB	0dBu (-3dBu for German PPM meter setting)	-18dBFS	ON	ON	ON	ON

Table 2 – Input Gain DIPswitch settings

The input gain setting can be changed at any time, without the need to remove power from the unit.

Note that the application of extra input gain reduces the maximum signal level permitted before signal clipping occurs. When the Level Alarm LED is configured to Input Clip, this indicator illuminates at the onset of clipping, with extended illumination indicating that the input gain should be reduced and/or the input signal levels attenuated.

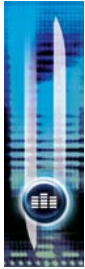

Remote Inputs and Outputs

A 15-way female D-type connector carries eight open-collector status outputs and four logic-level control inputs. The pin assignments are as follows:

Pin Number	I/O	Function
1	-	Ground
9	O	Audio input 1 under-level alarm – open collector with latching capability
2	O	Audio input 1 over-level alarm – open collector with latching capability
10	O	Audio input 1 sustained phase error alarm – open collector with latching capability
3	O	Audio input 1 AES/EBU lock output – non-latching open collector
11	O	Audio input 2 under-level alarm – open collector with latching capability
4	O	Audio input 2 over-level alarm – open collector with latching capability
12	O	Audio input 2 sustained phase error alarm – open collector with latching capability
5	O	Audio input 2 AES/EBU lock output – non-latching open collector
13	-	Ground
6	-	Ground
14	I	Audio Input 1 alarm reset – pull low to activate
7	I	Audio Input 2 alarm reset – pull low to activate
15	I	Reserved for future use
8	I	Reserved for future use

Table 3 – Remote Input and Output Connection Details

Open-collector outputs are low (conducting) when active. Open-collector outputs are rated at 50mA and 30V. See section Reference Monitor Meters Sci Remote Control Software for further details on alarm settings.

The AES/EBU Lock output is a real-time (non-latching) status output which becomes active if a valid AES/EBU signal is detected on the corresponding audio input. The open-collector output is low (conducting) when a valid AES signal is detected. The active-low control inputs all have internal pull-ups. Equipment driving these inputs need sink only 1mA and block 3.3V. Asserting the Alarm Reset input by pulling it low resets any active Alarm outputs to their un-triggered states and allows them to monitor for new alarm conditions.

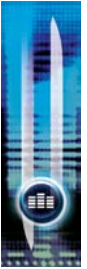

RS232 Remote Control

A 9-way female D-type connector carries a standard RS232 interface via which advanced configuration options may be set and many functions may be remotely controlled. The pin assignments are as follows:

Pin 2: Data transmit

Pin 3: Data receive

Pin 5: Ground

All other pins are unused.

All models of the Reference Monitor Meters will interface directly with personal computer serial ports at standard RS232 signal levels using a straight-through cable. The data format is 19200 baud with 8 data bits, even parity and 1 stop bit. XON/XOFF flow control is used when necessary.

Sonifex Sci software, when installed on a suitable PC, provides straightforward graphical access to all remote control and configuration options. Alternatively, commands may be issued from any text-based terminal program (e.g. Hyperterminal) or custom software may be developed for specific requirements

Sonifex Sci software is available free of charge from the sonifex website - www.sonifex.co.uk

Force Bootloader Mode – Bank “Settings 1” DIPSwitch 8

This mode should only be used if the unit fails to respond after a firmware upgrade attempt. With this DIP switch on, the Reference Monitor Meters will force the Bootloader to run and allow initiation of an update under any circumstances. Once an update has completed, this switch should be returned to the off position.

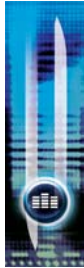

Serial Interface Commands & Responses Protocol

Sonifex SCi remote control software handles all communication with the Reference Monitors via a convenient graphical user interface. However, this protocol is provided for those users who wish to develop their own remote control applications or communicate with the Reference Monitors using a text-based terminal program.

For more information on how to install and operate the SCi software, please see section "Reference Monitor Meters SCi Remote Control Software".

Serial Data Format

Connection is initially 19200,e,8,1 with XON/XOFF flow control. Most of the commands follow the same structure: a 3 letter command followed by a colon, followed by a parameter (if any) and terminated by Carriage Return with optional Line Feed. A Line Feed character may be sent but it will be ignored. Commands are not case sensitive. Responses will be CR & LF terminated.

After the Reference Monitor Meters has been powered-up, an initialisation string is sent: "Initialising " followed by the model number and version number of the currently installed firmware.

Following are the commands and the expected responses:

Command	Description	Response
ALC:n	Clear alarm status where: n = 0 (input 1) n = 1 (input 2)	ACK: or ERR:
Bnn:	Set Baud Rate where: nn = 11 (115200 baud) nn = 57 (57600 baud) nn = 38 (38400 baud) nn = 19 (19200 baud) nn = 96 (9600 baud)	ACK: (at old rate)
FPL:n	Front panel lock where: n = 0 (unlock) n = 1 (lock)	ACK: or ERR:
DWN:	**Download firmware New firmware installed when correct	ACK:
	(ACK: indicates end of firmware file is received download can start)	

Command	Description	Response
LCK:	AES lock status request where: y = input 1 status (0=unlock, 1=lock) z = input 2 status (0=unlock, 1=lock)	LCK:yz
IPS:n	Set input select where: n = 0 (select input 1) n = 1 (select input 2) n = 2 (select mono mix) only valid for RM-M1-106	ACK: or ERR:
OPR:	Alarm option request where: k = Input 1 analogue under-level threshold (2 chars) l = Input 1 analogue over-level threshold (2 chars) m = Input 1 digital under-level threshold (2 chars) n = Input 1 digital over-level threshold (2 chars) o = Input 1 under-level timeout period (4 chars) p = Input 1 over-level timeout period (4 chars) q = Input 1 phase timeout period (4 chars) r = Input 1 alarm configuration options (4 chars) s = Input 2 analogue under-level threshold (2 chars) t = Input 2 analogue over-level threshold (2 chars) u = Input 2 digital under-level threshold (2 chars) v = Input 2 digital over-level threshold (2 chars) w = Input 2 under-level timeout period (4 chars) x = Input 2 over-level timeout period (4 chars) y = Input 2 phase timeout period (4 chars) z = Input 2 alarm configuration options (4 chars) level thresholds = 0–25 where: 0 = 0dBFS, 1 = -3dBFS, 2 = -6dBFS etc timeouts = 0–1000 in 0.2s units where: 0 = off, 1000 = 200secs alarm options: bit0 = alarm autoclear, bit1 = stereo, bit2 = front panel alarm=high level bit3 = front panel alarm=input clip bit2 & bit3 clear = front panel alarm=low level bit4 = channels linked (valid for Input 1 config only)	OPR:klmnopqrstuvwxyz

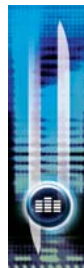

2

SERIAL INTERFACE COMMANDS & RESPONSES PROTOCOL

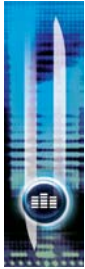

SERIAL INTERFACE COMMANDS & RESPONSES PROTOCOL

Command	Description	Response
OPW:klmnopqrstuvwxyz	Option write Parameters as per OPR: above	ACK: or ERR:
SER:	Serial number request where: z = serial number (6 chars)	SER:z
SRQ:	Status request where: s = channels (1 char) where: 1 = 1 stereo channel 2 = 2 stereo channels t = selected input (1 char) where: 0 = input 1 1 = input 2 2 = mono mix u = front panel lock (1 char) where: 0 = unlocked 1 = locked v = input 1 gain (1 char) where: 0 = 0dB 1 = +6dB 2 = +12dB 3 = +18dB w = input 1 meter type (1 char) where: 0 = Dual PPM/standard VU 1 = BBC/EBU PPM 2 = Nordic PPM 3 = AES Digital PPM 4 = DIN PPM 5 = Standard VU 6 = Extended VU 7 = German PPM 8 = AES Digital PPM (SMPTE RP.0155) x = input 2 gain where parameters as per v y = input 2 meter type where parameters as per w	STA:stuvwxyz

Command	Description	Response
SRQ (continued):	<p>z = status (4 chars) where:</p> <ul style="list-style-type: none"> bit 4 = Input 1 low-level alarm active bit 5 = Input 1 high-level alarm active bit 6 = Input 1 phase alarm active bit 7 = Input 1 AES lock bit 8 = Input 2 low-level alarm active bit 9 = Input 2 high-level alarm active bit 10 = Input 2 phase alarm active bit 11 = Input 2 AES lock 	
UID:	<p>**Unit id request where:</p> <p>x = number of stereo meter displays</p> <p>y = enclosure type: F = freestanding, R = rack mount</p> <p>z = meter segment display size: 53 or 106</p>	UID:RM-Mxyz
VER:	<p>**Version number request where:</p> <p>n.nn = firmware version (bootloader returns BOOT:Vn.nn)</p>	VER:Vn.nn

** = these commands also supported in Bootloader mode.



Error Messages

General error messages:

- ERR:01** - returned if command not found
- ERR:02** - returned if invalid command or missing/invalid parameter
- ERR:04** - returned if parameter out of range



Reference Monitor Meters SCi Remote Control Software

Sonifex SCi software is free of charge software available to control the Reference Monitor Meters range, as well as other Sonifex products, using RS232 connections.

Download the Latest SCi Software

This is located on the Sonifex website in the Software Downloads section: <http://www.sonifex.co.uk/technical/software/index.shtml> Download and install the software.

Connecting the RS232 Serial Port

Simply connect your Reference Monitor to your computer using a serial cable and you are ready for operation.

Using SCi for the First Time

Once you have connected the serial cable, double click the SCi icon. You will be presented with the SCi Launcher:

Click on the large 'Plus' button and the software will try and communicate with the relevant serial ports to 'discover' your connected devices.

Your attached Reference Monitor Meters unit(s) will be shown in the list. If they are not listed, check the cable(s) between the unit and your PC. Close the device dialog by clicking on the cross in the top right corner.



Fig 3-1: SCi Launcher

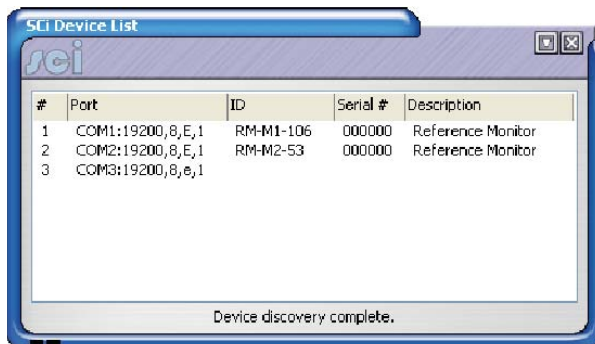

Fig 3-2: SCi Device Discovery Panel

The Reference Monitor now appears in the SCi Launcher.

Loaded Launcher

Click on this to connect to the selected Reference Monitor Meters. The Main screens will be displayed.

Sci for Reference Monitor Meters – Main Status Screen

The graphical interface allows you to monitor and control the Reference Monitor Meters remotely. The main Status panel shows the controls and status indicators that are relevant to the connected model. For RM-M1-53 and RM-M2-53 models, the Status screen shows selected Input Gain, Meter Types and AES Lock and Alarm status for each audio input.

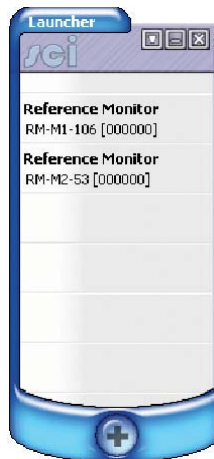
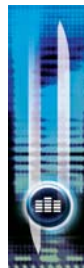

Fig 3-3: Sci Launcher Loaded



Fig 3-4: Sci Main Status Screen for RM-M2-53

For the RM-M1-106 the Status screen also shows controls for Input Select and a Front Panel Lock control to prevent accidental or un-authorised changes to the selected monitoring channel. Please note that Sci is continuously updated so the images may appear differently to those shown.



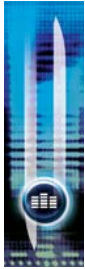

Fig 3-5: SCI Main Status Screen for RM-M1-106

The Clear Alarm button resets any active alarm on the corresponding input. Its action is similar to asserting the Alarm Reset on the rear panel mounted Remote port.

SCI for Reference Monitor Meters – Options Screen

This Options Screen allows the alarm options to be easily edited.

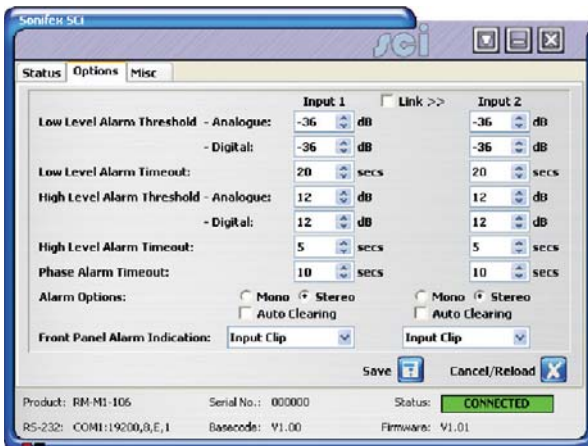

Fig 3-6: SCI Options Screen

The alarm settings for each available audio input can be individually configured. Figure 3-6 shows the default values for each setting. The Low Level and High Level Alarm Thresholds have a separate setting for Analogue and Digital inputs and the appropriate level is automatically used when monitoring for alarm conditions. The Level Timeout values define the period during which the audio input level must remain either below the Threshold for a Low Level Alarm, or above the Threshold for a High Level Alarm.

The Phase Alarm condition is preset and will activate when the phase difference between left and right channels of the corresponding audio input, remains above 90 degrees for longer than the Phase Alarm Timeout.

Each of the alarms can be disabled by selecting 0 seconds for the corresponding Timeout value.

With the Stereo Alarm option set, an alarm condition is activated only when both the left and right channels of the corresponding audio input satisfy the alarm conditions. With the Mono option set, either channel can activate the alarm.

The Auto Clearing option allows alarms to be automatically cleared when the alarm condition no longer exists. With this option not set, the alarm must be cleared manually, either by selecting the Clear Alarm button on the Status screen in SCI, or by activating the corresponding Alarm Reset input on the Remote Port.

The Front Panel Alarm Indication setting specifies which alarm condition will activate the Level Alarm LED. The Low Level Alarm and High Level Alarm options illuminate the Level Alarm LED when the corresponding alarm activates. With the Input Clip option selected, the Level Alarm LED will illuminate when the input signal level has either exceeded or come within 0.5dB of the maximum acceptable input level.

Once the required Options have been set, pressing the Save button will send the changes to the Reference Monitor Meters unit where they are saved in non-volatile memory. The Cancel/Reload button displays the current settings and aborts any changes.

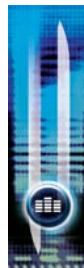



Firmware Updates

The Misc screen shows the Update Firmware option.



Fig 3-7: SCI Misc Screen

Occasionally, it may be necessary to upgrade the firmware on the Reference Monitor Meters to add new functionality and fix software bugs. New firmware updates will be made available from time to time on the Sonifex website. Visit www.sonifex.co.uk for details.

It is vital that neither the serial connection nor mains power to the unit should be interrupted during the update process. If this should happen, or the update is unsuccessful for any other reason, the Reference Monitor Meters will not operate normally and will instead enter a protected Bootloader mode. In this mode, the unit has a limited command set and will await a successful retry of the update process.

Should the firmware update appear to succeed but the unit not behave as expected, the update may be repeated either via the DWN: command (if the unit will respond to commands) or, in extreme circumstances, by setting DIPSwitch number 8 in the "Settings 1" Bank to ON. This action will force the Bootloader to run and allow initiation of an update under any circumstances. After completion of the update, the switch should be returned to the OFF position.

To upgrade the firmware on the connected Reference Monitor Meters, click on the Update Firmware button and select the required firmware file. The new firmware is transferred, and then the current firmware is erased before programming the update.

Technical Specification

Inputs

Audio Inputs: 1 x stereo analogue or AES/EBU digital (auto-selecting)
(RM-M1F53 & RM-M1R53)
2 x stereo analogue or AES/EBU digital (auto-selecting)
(RM-M2F53, RM-M2R53, RM-M1F106 & RM-M1R106)
4 x stereo analogue or AES/EBU digital (auto-selecting)
(RM-M4R53 & RM-M2R106)

Max. Level: +18dBu (analogue)/0dBFS (0dB Input Gain)

CMRR: >60dB typical

Input Impedance: 20kΩ (analogue) 110Ω (digital with termination switchable via DIPSwitch)

AES/EBU 32 to 192kHz, converted internally to 48kHz

Sample Rate:

Input Gain: 0, +6, +12 or +18dB digital gain (switchable via DIPSwitch)

Level Metering

Number: 2 x 53 segment tri-colour LED bar graphs
(RM-M1F53 & RM-M1R53)
4 x 53 segment tri-colour LED bar graphs
(RM-M2F53 & RM-M2R53)
8 x 53 segment tri-colour LED bar graphs
(RM-M4R53)
2 x 106 segment tri-colour LED bar graphs
(RM-M1F106 & RM-M1R106)
4 x 106 segment tri-colour LED bar graphs
(RM-M2R106)

Characteristic: Selectable by DIPSwitch from:

Dual BBC PPM + Standard VU	
BBC PPM	IEC60268-10 11a
EBU PPM	IEC60268-10 11b
Nordic PPM	IEC60268-10 1
AES/EBU Digital	PPM IEC60268-18
DIN PPM	DIN45406
Standard VU	IEC60268-17
Extended VU	IEC60268-17
German PPM	

Ballistics: According to selected characteristic

Line-Up Level: 0dBFS = +18dBu (except German PPM: 0dBFS = +15dBu)

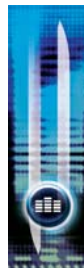

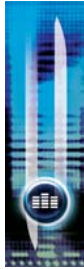

Phase Metering

Type: 5-segment, indication at 0°, 45°, 90°, 135° and 180°,
1 per stereo meter

Remote Control

Serial: RS232, 19200 baud, 3-wire connection

Alarm Outputs: (1-4 single units, 1-8 twin units)
 Audio input 1 under-level/fail (with latching capability)
 Audio input 1 over-level (with latching capability)
 Audio input 1 sustained phase error above 90°
 (with latching capability)
 AES/EBU input 1 lock (non-latching)
 Audio input 2 under-level/fail (with latching capability)
 Audio input 2 over-level (with latching capability)
 Audio input 2 sustained phase error above 90°
 (with latching capability)
 AES/EBU input 2 lock (non-latching)
 Open-collector outputs rated 30V, 50mA maximum

Control Inputs: (1 single input units, 2 twin input units)
 1. Input 1 Alarm reset
 2. Input 2 Alarm reset
 Pull-to-ground to activate inputs

Status Indicators

AES Lock: Indicates lock achieved on corresponding digital input

Level Alarm: Indicates audio under-level, over-level or input clip
 on corresponding audio input (dependent on setting)

Connectors

Audio Inputs: (All balanced, but may be wired unbalanced)
 2 x XLR 3-pin female (RM-M1F53 & RM-M1R53)
 4 x XLR 3-pin female (RM-M2F53, RM-M2R53,
 RM-M1F106 & RM-M1R106)
 8 x XLR 3-pin female (RM-M4R53 & RM-M2R106)

RS232 Serial: D-sub 9-pin female

Remote I/O: D-sub 15-pin female

Mains Input: Filtered 3-pin IEC male, continuously rated 85 – 264VAC,
 47 – 63Hz, fused 1A, 30W peak, 15W average

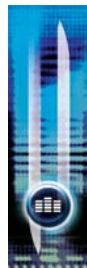

DIPSwitch Settings 1

SW1	Digital Input 1 Termination	Input 1 110Ω ON	Un-terminated OFF
SW2	Digital Input 2 Termination	Input 2 110Ω ON	Un-terminated OFF
SW3	Input 1 Gain Matrix		
SW4	Input 1 Gain Matrix		
SW5	Input 2 Gain Matrix		
SW6	Input 2 Gain Matrix		
SW7	Reserved		
SW8	Firmware Update	Force Bootload ON	Normal Operation OFF

DIPSwitch Settings 2

SW1	Input 1 Meter Ballistics & Scaling Matrix
SW2	Input 1 Meter Ballistics & Scaling Matrix
SW3	Input 1 Meter Ballistics & Scaling Matrix
SW4	Input 1 Meter Ballistics & Scaling Matrix
SW5	Input 2 Meter Ballistics & Scaling Matrix
SW6	Input 2 Meter Ballistics & Scaling Matrix
SW7	Input 2 Meter Ballistics & Scaling Matrix
SW8	Input 2 Meter Ballistics & Scaling Matrix

Equipment Type

RM-M1F53	1 stereo 53 segment meter, free-standing
RM-M1R53	1 stereo 53 segment meter, rack-mount
RM-M2F53	2 stereo 53 segment meters, free-standing
RM-M2R53	2 stereo 53 segment meters, rack-mount
RM-M4R53	4 stereo 53 segment meters, rack-mount
RM-M1F106	1 stereo 106 segment meter, free-standing
RM-M1R106	1 stereo 106 segment meter, rack-mount
RM-M2R106	2 stereo 106 segment meters, rack-mount

Physical Specification

Dimensions (Raw):	RM-M1F53, RM-M2F53 & RM-M1F106 21.8cm (W) x 14.8cm (D) x 4.4cm (H) 8.6" (W) x 5.8" (D) x 1.73" (H)
-------------------	--

Dimensions (Boxed):	RM-M1F53, RM-M2F53 & RM-M1F106 59cm (W) x 20.5cm (D) x 6cm (H) 21" (W) x 8" (D) x 2.4" (H)
---------------------	--

4

TECHNICAL SPECIFICATION



TECHNICAL SPECIFICATION

Dimensions RM-M1R53, RM-M2R53, RM-M4R53, RM-M1R106 & RM-M2R106
(Raw): 48cm (W) x 14.8cm (D) x 4.4cm (H)
19" (W) x 5.8" (D) x 1.73" (H)

Dimensions RM-M1R53, RM-M2R53, RM-M4R53, RM-M1R106 & RM-M2R106
(Boxed): 59cm (W) x 20.5cm (D) x 6cm (H)
21" (W) x 8" (D) x 2.4" (H)

Weight: RM-M1F53 & RM-M1R53
Nett: 1.3kg Gross: 2.0kg
Nett: 2.9lb Gross: 4.4lb

Weight: RM-M2F53 & RM-M1F106
Nett: 1.4kg Gross: 2.1kg
Nett: 3.1lb Gross: 4.6lb

Weight: RM-M2R53 & RM-M1R106
Nett: 1.45kg Gross: 2.15kg
Nett: 3.2lb Gross: 4.7lb

Weight: RM-M4R53 & RM-M2R106
Nett: 2.8kg Gross: 3.5kg
Nett: 6.2lb Gross: 7.7lb

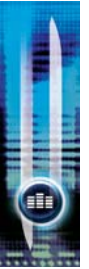

NOTES

SONIFEX

www.sonifex.co.uk

t:+44 (0)1933 650 700

f:+44 (0)1933 650 726

sales@sonifex.co.uk

